

09/2020

Dok.-Nr. 2.551.025.1.i

www.janitza.de

# RESIDUAL CURRENT MEASUREMENT DEVICE RCM 202-AB

User manual and technical data



Janitza electronics GmbH  
Vor dem Polstück 6  
D-35633 Lahnu, Germany  
Support Tel. +49 6441 9642-22  
E-Mail: info@janitza.de  
www.janitza.de

**Janitza®**



## Table of contents

<b>1</b>	<b>Information about using this user manual .....</b>	<b>7</b>
1.1	General information .....	7
1.2	Abbreviations used .....	7
1.3	Notes on terminology.....	7
<b>2</b>	<b>Safety instructions .....</b>	<b>8</b>
2.1	Symbols used .....	8
2.2	General safety instructions .....	8
<b>3</b>	<b>Purpose - Intended use .....</b>	<b>9</b>
<b>4</b>	<b>Scope of delivery .....</b>	<b>10</b>
<b>5</b>	<b>Overview of the RCM 202-AB.....</b>	<b>10</b>
5.1	Device view .....	10
5.2	Device dimensions.....	11
5.3	Labeling .....	11
<b>6</b>	<b>Functions .....</b>	<b>12</b>
6.1	Basic functionality .....	12
6.1.1	Residual current monitoring principle.....	12
6.1.2	Current measurement transformer monitoring.....	13
6.2	Parameterization options .....	13
6.2.1	Warning and alarm thresholds.....	14
6.2.2	Hysteresis.....	14
6.2.3	Delay times.....	15
6.3	Extreme value storage.....	16
6.4	Measured value memory/historical data .....	16
6.5	RS485 interface (Modbus).....	17
6.6	Digital outputs .....	19
6.7	Analog outputs (interfaces 4 ... 20 mA).....	19
<b>7</b>	<b>Connection assignment .....</b>	<b>20</b>
<b>8</b>	<b>Application example.....</b>	<b>22</b>
8.1	Application example RCM 202-AB in stand-alone mode .....	22
8.2	Application example analog outputs (interface 4 ... 20 mA) .....	22
8.3	Application example analog outputs and UMG 96RM-E.....	23
8.4	Application examples via Modbus (RS485 interface).....	24
<b>9</b>	<b>Assembly, commissioning and configuration .....</b>	<b>25</b>
9.1	Assembly (initial installation).....	25
9.2	Commissioning .....	26
9.3	Configuration (parameterization) .....	27

<b>10</b>	<b>Display and operating elements</b>	<b>27</b>
10.1	Display and keys	27
10.2	Meaning of the status LED	29
10.3	Key functions	29
10.4	Menu release	29
<b>11</b>	<b>Operation</b>	<b>30</b>
11.1	Release and block of parameterization mode	30
11.2	Operating steps for displaying and changing values in the menu	31
11.3	Operating steps for checking the monitoring function	33
<b>12</b>	<b>Configuration menu</b>	<b>34</b>
12.1	Menu: 1.Basic settings	36
12.1.1	Menu item: LCD contrast	36
12.1.2	Menu item: Change date/time	36
12.1.3	Menu item: Language	37
12.1.4	Menu item: Parameter release	37
12.1.5	Menu item: Change password	37
12.2	2.Channel parameter	38
12.2.1	Menu item: Channel active	39
12.2.2	Menu item: Transformer type	39
12.2.3	Menu item: Monitoring active	40
12.2.4	Menu items: Warning th. I to warning th. I AC50	40
12.2.5	Menu items: Alarm th. I to alarm th. I AC50	41
12.2.6	Menu item: Autom. reset	42
12.2.7	Menu item: Hysteresis	42
12.2.8	Menu item: Response delay	42
12.2.9	Menu item: Reset delay	42
12.2.10	Menu items: Digital output 1 and digital output 2	43
12.2.11	Menu item: Factor 4-20mA = 20 A	43
12.3	Menu: 3.Communication	44
12.3.1	Menu item: Modbus active	44
12.3.2	Menu item: Address	45
12.3.3	Menu item: Baud rate	45
12.4	Menu: 4.Measured value memory	45
12.4.1	Menu item: Record active	45
12.4.2	Menu item: Interval	46
12.4.3	Menu item: Delete record	46
12.5	Menu: 5.Min/max values	46
12.5.1	Menu items: Channel 1 and channel 2	47
12.6	Menu: 6.Functional test	48
12.6.1	Menu item: Test interval	48

12.6.2	Menu item: last test.....	49
12.7	Menu: 7.Service.....	49
12.7.1	Menu item: Transformer analysis.....	50
12.7.2	Menu item: Power frequency .....	51
12.7.3	Menu item: Current value AC .....	51
12.8	Menu: 8.Factory setting .....	51
12.9	Menu: 9.Information.....	52
12.10	Menu: 10.Restart.....	52
<b>13</b>	<b>Servicing .....</b>	<b>53</b>
13.1	Periodic inspection.....	53
13.2	Maintenance .....	53
<b>14</b>	<b>Troubleshooting .....</b>	<b>54</b>
14.1	Errors and their remediation .....	54
14.1.1	The status LED is off .....	55
14.1.2	The status LED flashes green .....	55
14.1.3	The status LED lights up green .....	55
14.1.4	The status LED flashes yellow.....	56
14.1.5	The status LED flashes red .....	56
14.1.6	The status LED lights up red .....	57
14.2	Replacement of a defective RCM 202-AB .....	58
14.2.1	Removal of a defective RCM 202-AB .....	58
14.2.2	Installation of a new RCM 202-AB .....	58
<b>15</b>	<b>Warranty and liability .....</b>	<b>59</b>
<b>16</b>	<b>Storage .....</b>	<b>59</b>
<b>17</b>	<b>Disposal.....</b>	<b>59</b>
<b>18</b>	<b>Declaration of conformity .....</b>	<b>60</b>
<b>19</b>	<b>Technical data.....</b>	<b>60</b>
19.1	General technical data.....	60
19.2	RCM 202-AB plug.....	63
19.3	Current measurement transformer.....	63



## 1 Information about using this user manual

### 1.1 General information

This user manual is intended exclusively for use by trained specialized electrotechnical personnel.

This user manual is a part of the product and makes reference to other devices from Janitza electronics GmbH. Only the names of the respective device series are specified, but not all the associated types. Read this user manual before using the device. Observe all safety requirements and warning notices. Failure to observe the instructions can lead to personal injury and/or damage to the product.

Keep the user manual through the entire service life of the product so it is available for all users.

### 1.2 Abbreviations used

Abbreviation	Meaning
Modbus	Communication protocol based on a master/slave architecture
DW	Residual current transformer
H	Hysteresis
$I_G$	Residual current
k	S1 (transformer connection)
l	S2 (transformer connection)
oAS	Upper alarm threshold
oWS	Upper warning threshold
t	Time
$t_v$	Delay time for warning and alarm message
$t_{vr}$	Reset delay time for warning and alarm message

### 1.3 Notes on terminology

Work steps and processes are illustrated as follows:

“1. ...”, even if there is only one work step, this format is used.

The standards indicated in the continuous text are written in abbreviated form, and the complete designation can be found in chapter 19.1, from page 62.

## 2 Safety instructions

### 2.1 Symbols used



#### **WARNING**

These symbols and the word “warning” are used when there is possible danger to life and limb.



Symbols are also used in these instructions that refer directly to the source of danger.



#### **ATTENTION**

This symbol and the word “attention” are used when there is the possibility of property damage.



#### **Observe the user manual!**

This symbol and “Observe the user manual!” are used when reference must be made to the user manual or other documentation.



#### **NOTE**

This symbols and the word “Note” are used to make reference to additional information necessary for device use.

### 2.2 General safety instructions

The following safety instructions must be observed for work on and with the RCM 202-AB. Specific safety instructions are also listed in the respective chapters.



#### **WARNING**

All work necessary for the connection, assembly, commissioning and operation of the device may only be performed by well trained and instructed specialist personnel. The specialist personnel must observe and comply with the relevant applicable standards and directives for work on electrical systems (e.g. DIN EN 50110 and ff./ directives and regulations of professional associations in Germany).



**ATTENTION**

Use of the device requires sufficient knowledge of the product as well as knowledge about the connected devices and systems. Changes to the pre-set values and control commands influence the evaluation behavior of the residual current measurement device. Therefore changes to the commissioning settings as well as the replacement of devices may only be carried out upon agreement with Janitza electronics GmbH!

Changes carried out are to be documented in the system documentation!

**Observe the user manual!**

This user manual as well as the device-specific user manuals for connected devices must be strictly observed.

**NOTE**

The RCM 202-AB is supplied as a component of a residual and operating current monitoring system. Upon commissioning/delivery of a monitoring system, all system-specific settings and control commands for the RCM 202-AB shall be parameterized and documented by Janitza electronics GmbH.

### 3 Purpose - Intended use

The RCM 202-AB is a two-channel residual current measurement device for the measurement and monitoring of main distribution boards up to a maximum residual current of 20 A.

With connected current measurement transformers (also current sensors), the RCM 202-AB is used for the measurement and monitoring of residual currents in TN and TT systems (grounded AC systems).

With additional devices of the RCM series, display devices or devices for data coupling to third-party systems, it forms a complete residual and operating current monitoring system. This monitoring system increases system and operational safety. Faults or an increase in residual currents (usually creeping) are detected early on, for example, thus allowing preventative maintenance. The external signal current circuits used in the monitoring system shall be secondary current circuits.

Any use of the RCM 202-AB that differs from the description in this manual is considered improper use and may affect the protection provided by the device.

## 4 Scope of delivery

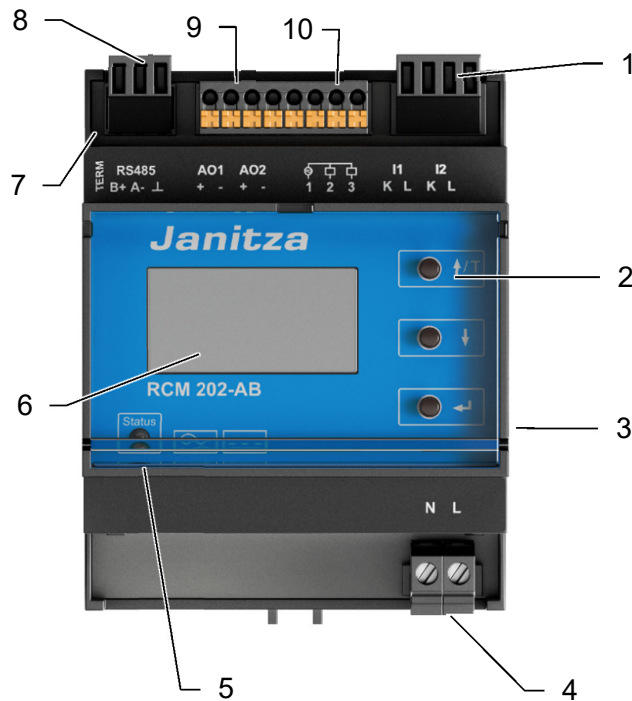
The following components are part of the scope of delivery of an individual device:

- 1 x RCM 202-AB
- 1 set of plugs (on the device)
- 1 x user manual

Check the scope of delivery to ensure it is complete and immediately report any damage or missing content to the manufacturer/sales partner.

## 5 Overview of the RCM 202-AB

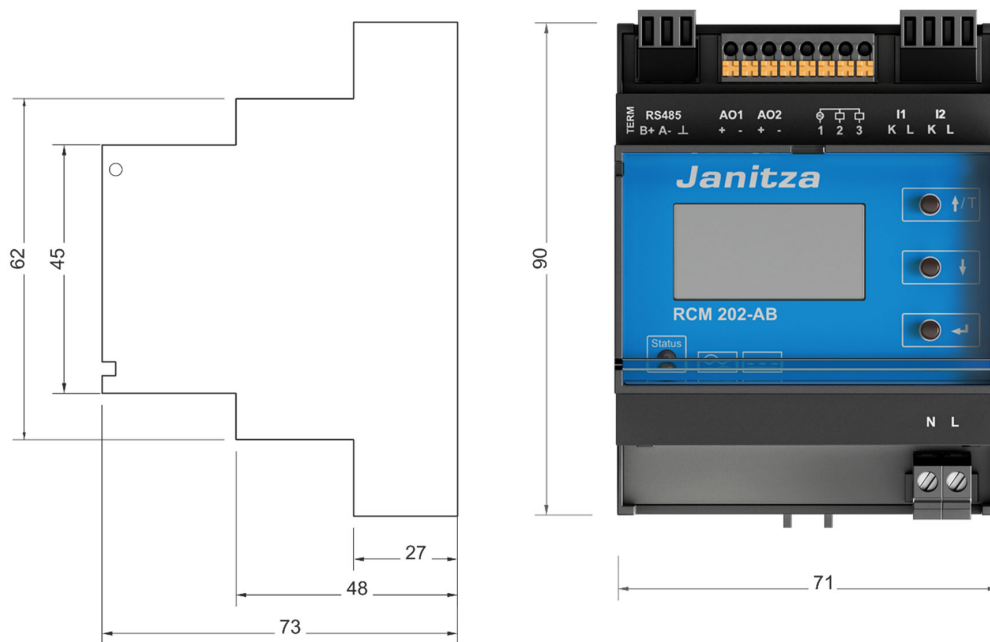
### 5.1 Device view



**Fig. 1:** RCM 202-AB device view

- |   |  |    |  |
|---|--|----|--|
| 1 | Connection for 2 current measurement transformers      | 7  | Modbus termination switch                        |
| 2 | Operating keys   | 8  | Modbus connection (RS485 interface)              |
| 3 | Label with manufacturer, serial number and item number | 9  | Analog output connection (interface 4 ... 20 mA) |
| 4 | Supply voltage connection                              | 10 | Digital output connection                        |
| 5 | Status LED   |    |  |
| 6 | Display  |    |  |

## 5.2 Device dimensions



**Fig. 2:** Device dimensions in mm

## 5.3 Labeling

Various labels are applied on the RCM 202-AB with the following information:

- Manufacturer
- Serial number and item number
- Technical data (short form)
- CE mark

## 6 Functions

### 6.1 Basic functionality

The main functions of the RCM 202-AB are:

- Residual current measurement via a connected current measurement transformer (max. 2 current measurement transformers)
- Transformer connection monitoring for wire breaks or short circuit per channel
- Effective value measurement (true RMS)
- Parallel measured value recording
- Evaluation of fault currents (residual currents) type A and B according to IEC 62020
- Detection of sinusoidal residual fault currents with frequencies up to 20 kHz (type B+)
- Measured value and extreme value storage with time stamp
- Parameterizable alarm threshold for alarm message per channel
- Parameterizable warning threshold (e.g. prewarning) for warning message per channel
- Parameterizable delay times:
  - Delay time for warning and alarm messages
  - Reset delay time for warning and alarm messages
- Operating and error messages shown on the display
- Communication via Modbus (RS485 interface/Modbus RTU)
- Evaluation possibility with the help of the GridVis® monitoring system or a display and evaluation device

#### 6.1.1 Residual current monitoring principle

The fault currents (residual currents) flowing to ground or other paths are recorded via the connected current measurement transformers.

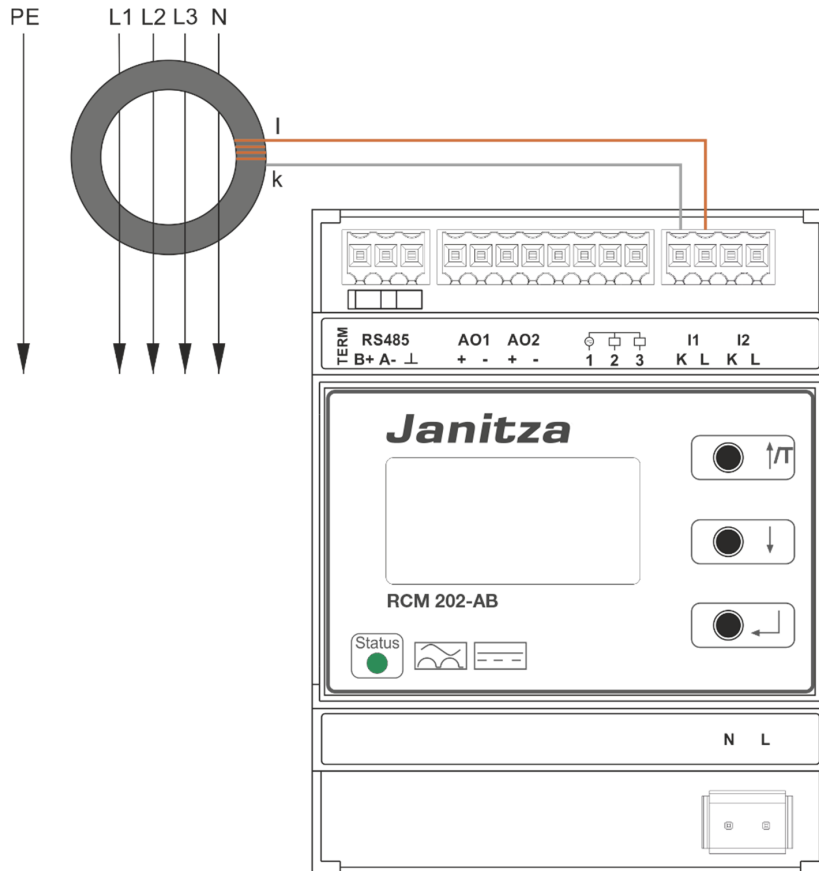
For example:

- Outflow-related residual currents (consumers and systems)
- Stray currents in TN-S systems (PEN and N conductors)



### ATTENTION

Do not route the PE conductor through the current measurement transformer!



**Fig. 3:** Simplified presentation of residual current measurement

### 6.1.2 Current measurement transformer monitoring

The RCM 202-AB evaluates currents from up to two current measurement transformers at the same time. For each active channel, the RCM 202-AB continuously checks the connected transformer for short circuit or wire breaks. If a short circuit or wire break occurs on the transformers, an error message is output on the display as well as on the communication interfaces and the LED status flashes red.

### 6.2 Parameterization options

The parameters are described in the following sub-chapters, which can be changed in the menu of the RCM 202-AB.

### 6.2.1 Warning and alarm thresholds

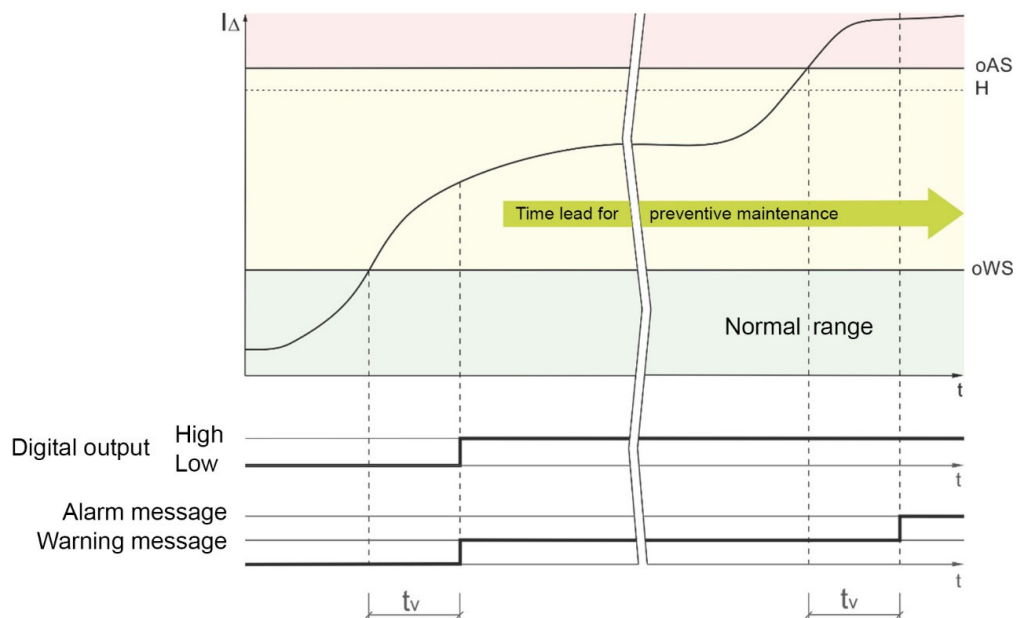
Warning and alarm thresholds are parameterizable thresholds, which can be adapted to the currents to be monitored. They can be adjusted separately for each channel.

When reaching these thresholds, warning or alarm messages are sent. The status LED lights up yellow and channel-related text messages are shown on the display.

**Example:** Exceedance of warning and alarm thresholds

**Parameterization:** The digital output reacts to warning and alarm thresholds (When the warning and alarm thresholds are exceeded, the messages can be called up via Modbus after the delay time has elapsed.)

Delay time  $t_v > 0$  s



**Fig. 4:** Response and warning thresholds and the resulting messages

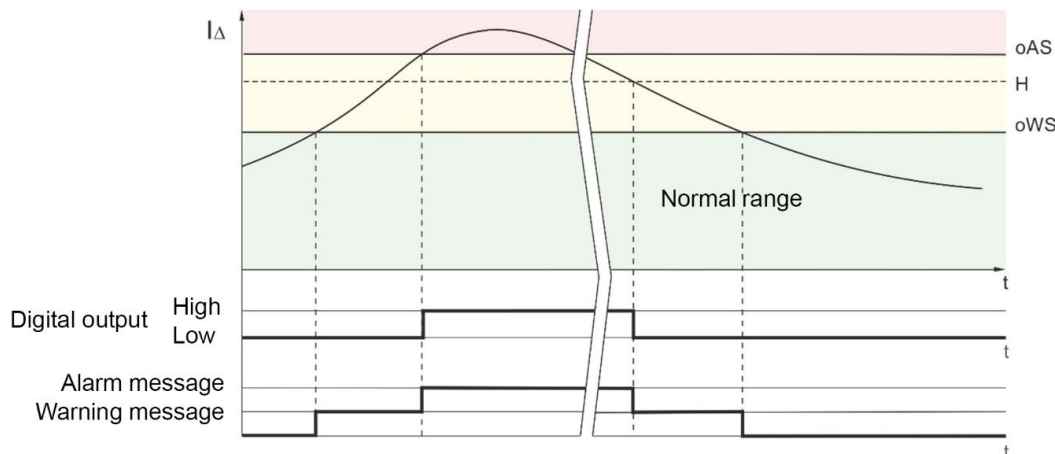
### 6.2.2 Hysteresis

Alarm thresholds have a parameterizable hysteresis. They are defined separately for each channel.

If the residual current, for example, exceeds the upper alarm threshold and then goes back down, the alarm message is reset after the hysteresis is fallen below and the parameterized reset delay time, if applicable, has passed.

**Example:** Exceedance of warning and alarm thresholds with signal paths

**Parameterization:** The digital output reacts to alarm thresholds  
(When the warning and alarm thresholds are exceeded, the messages can be called up via Modbus after the delay time has elapsed.)



**Fig. 5:** Evaluation of the set hysteresis for messages

### 6.2.3 Delay times

The following delay times can be set for residual current monitoring per channel:

- Delay time for warning and alarm messages ( $t_v$ )
- Reset delay time for warning and alarm messages ( $t_{vr}$ )

#### Delay time for warning and alarm messages

Temporary threshold violations are not reported with parameterization of a delay time for warning and alarm messages.

Messages are not taken into consideration during the parameterized delay time ( $t_v$ ). They are only displayed and updated in Modbus if the current path still lies above the warning or alarm threshold after the delay time has elapsed. Only then will the digital output be set, if configured.

#### Reset delay time for warning and alarm messages

If there are no more messages, the RCM 202-AB resets the warning and alarm messages. The reset delay time ( $t_{vr}$ ) for the warning and alarm messages can be parameterized and is needed to ignore brief fluctuations. When resetting a message, also the digital output is reset.

If the current path goes down and falls below the hysteresis or the upper warning threshold, the reset delay time ( $t_{vr}$ ) is activated.

During this time, the respective message remains active and the digital output is set.

If the current path remains below the hysteresis after the reset delay time has elapsed, the messages and the digital output are reset.

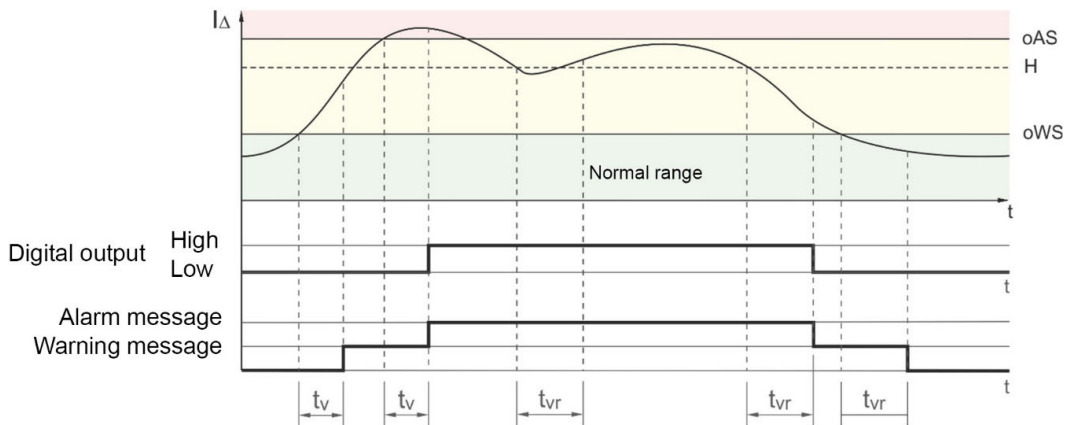
**Example:** Exceedance of warning and alarm thresholds with signal paths

**Parameterization:** The digital output reacts to alarm thresholds

(When the warning and alarm thresholds are exceeded, the messages can be called up via Modbus after the delay time has elapsed.)

Delay time  $t_v > 0$  s

Reset delay time  $t_{vr} > t_v$



**Fig. 6:** Effects of the delay times on messages

### 6.3 Extreme value storage

The RCM 202-AB stores the minimum and maximum values of residual current measurement for each current channel with a time stamp.

The stored extreme values can be displayed by channel on the display and reset or read out via Modbus.

### 6.4 Measured value memory/historical data

The RCM 202-AB files cyclical data sets of measured values in the internal memory. This enables a later evaluation/report generation. The device-internal memory serves as a buffer for the measured value database of the evaluation software, which connects to the RCM 202-AB according to schedule (e.g. monthly) in order to read out the data sets. During a connection, the data collected is read and sorted in the database so that a complete history exists.



The measured value memory is described circularly (circular buffer principle). If the memory is full, the oldest data is overwritten. The period of time until the stored, historical data is overwritten is dependent on the measurement interval (time base for averaging). The measurement interval is set in the configuration menu.

Measurement interval for averaging	Period of time available
60 s (1 min)	13 days
300 s (5 min)	65 days
600 s (10 min)	130 days
900 s (15 min)	195 days
1800 s (30 min)	390 days
3600 s (60 min)	780 days

**Tab. 1:** Available memory as a period of time depending on the measurement interval

The data set contains the following values, which are calculated as the mean value over the set measurement interval:

- Start and end time of the interval
- Total current (residual current type B+)
- Total current up to 2 kHz (residual current type B)
- Direct current
- Alternating current with frequencies up to 2 kHz (residual current type A)
- Alternating current with frequencies up to 20 kHz
- Fundamental oscillation

The measured value memory is not deleted automatically during operation. Data read is not lost, except it is overwritten during the circulation of the memory. Therefore, multiple databases (even on different computers) are kept current. When updating, a database only reads out the data that has been newly stored since its last updating.

It is possible to manually delete the measured value memory via the configuration menu.

## 6.5 RS485 interface (Modbus)

The RCM 202-AB has a Modbus interface (RS485) and works with the Modbus RTU protocol as a slave. The device address 1 and the baud rate of 19200 baud are factory-set.

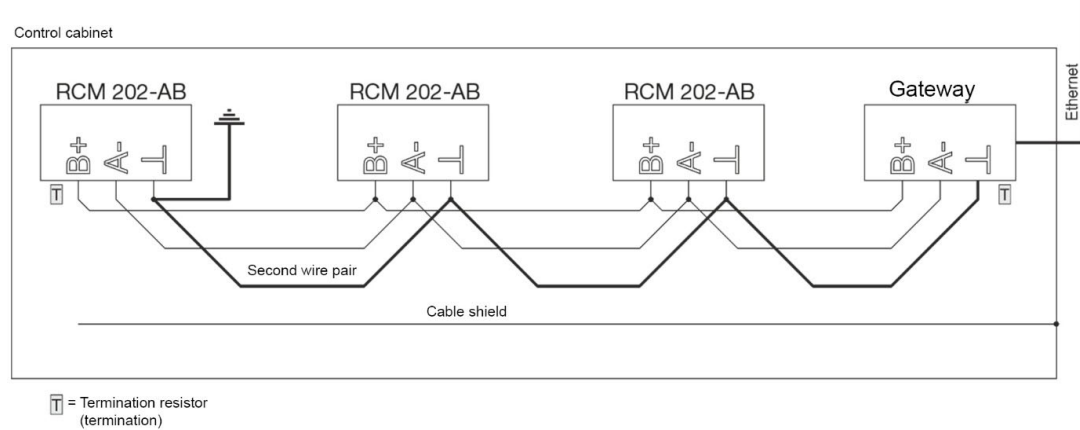


### WARNING

The open ground connection of the RS485 interface may not be touched! There is a risk of electric shock.

## Bus structure

The bus structure of the individual Modbus segments is basically linear. Up to 247 participants can be connected in a Modbus segment. If the data volume of the Modbus participants is too large, the number of participants must be reduced. The cable is closed with resistors at the start and end of a segment.



**Fig. 7:** simplified connection diagram of the RS485 interface (example)

## Termination resistors

The D+/D- data line of a Modbus segment must always be provided with a termination resistor of 120  $\Omega$  at the start and end to prevent reflections (termination).

## Shielding

Twisted and shielded cable is always used for connections via the Modbus interface (RS485). For a sufficient shielding effect, the shielding must be connected extensively to one end of a cable with a grounded housing or cabinet parts.

## Connection

The twisted wires of the cable must be connected to terminals “B+” and “A-”. In order to equalize the potential differences between multiple RCM 202-AB, the ground terminals of all devices on the bus must be connected together. The second twisted wire pair of the bus cable is used for potential equalization. Both wires must be connected to each ground terminal. The ground cable from both wires must be connected to one end of the bus cable with PE.



### WARNING

The power supply connection and the transformer connections of the RCM 202-AB may be switched on only after connecting the ground terminal and grounding the ground cable.

There is a risk of electric shock.

## 6.6 Digital outputs



### ATTENTION

External signal current circuits must be secondary current circuits if the RCM 202-AB is integrated in a monitoring system.

The digital outputs are not short-circuit proof.  
Cables that are longer than 30 m must be installed shielded.

The RCM 202-AB has two transistor switching outputs. These digital outputs are electrically isolated from the evaluation electronics via optocouplers.

- The digital outputs switch direct current or alternating current loads.
- The digital outputs switch loads independently of the polarity of the supply voltage.

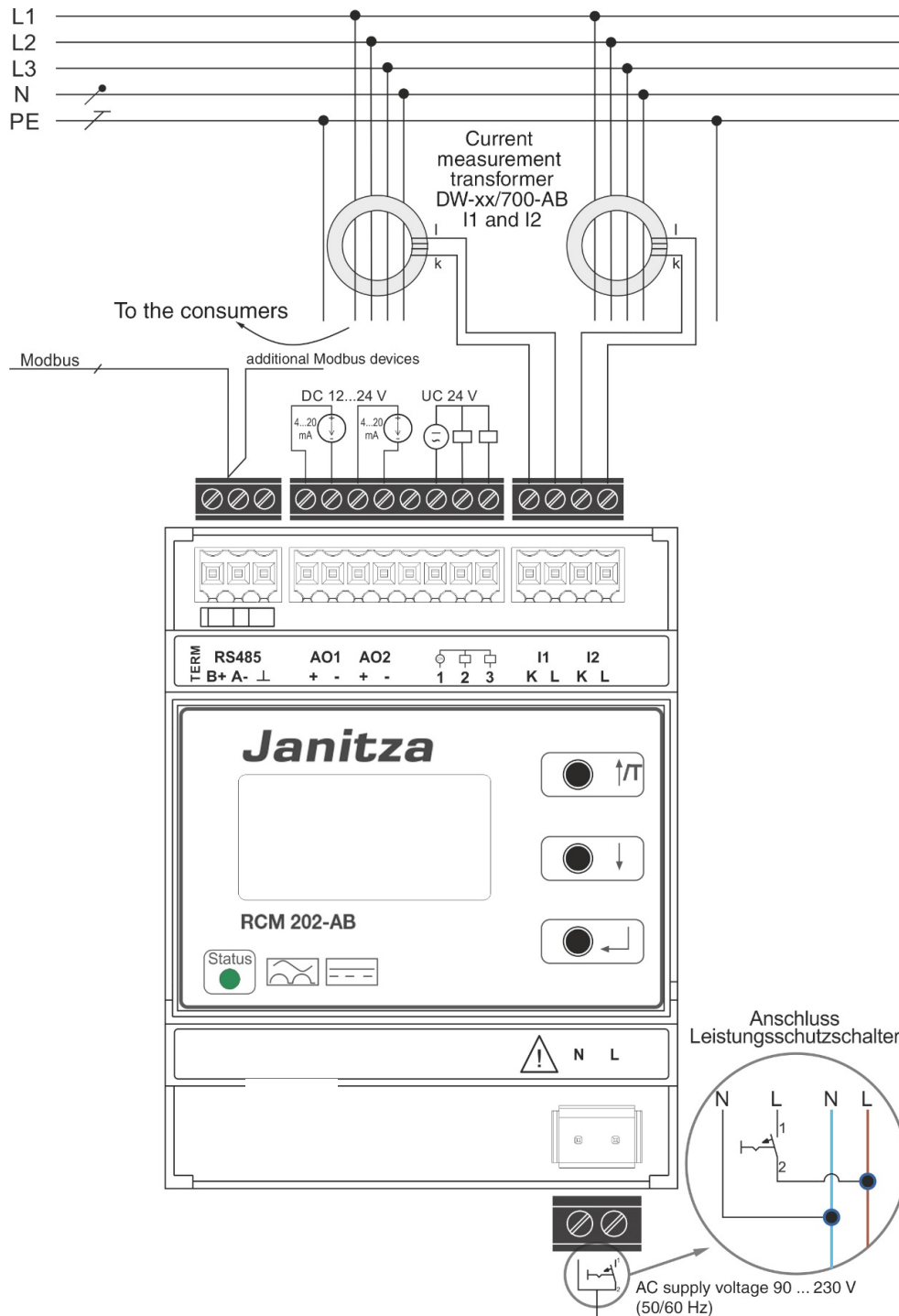
## 6.7 Analog outputs (interfaces 4 ... 20 mA)

The RCM 202-AB has two analogue outputs (interfaces 4 ... 20 mA). The analogue outputs output the effective value of the measured total current. Both analogue outputs require a separate power supply (DC 12 ... 24 V). In the configuration menu of the RCM 202-AB, the measuring range (total current) can be scaled. In systems with low total currents, this makes it possible for the measured total current to be evaluated in a more precise manner. The message “overflow” is displayed when the set measuring range (total current) is exceeded and can be called up via Modbus.


Set value “Factor 4 ... 20 mA”:	5 A	10 A	15 A	20 A
<b>Measured total current</b>	<b>Output value of the analog output</b>			
0.00 A	4.0 mA	4.0 mA	4.0 mA	4.0 mA
2.45 A	11.8 mA	7.9 mA	6.6 mA	6.0 mA
2.50 A	12.0 mA	8.0 mA	6.7 mA	6.0 mA
2.60 A	12.3 mA	8.2 mA	6.8 mA	6.1 mA
5 A	20 mA	12 mA	9.3 mA	8.0 mA
10 A	Error	20.0 mA	14.7 mA	12.0 mA
14 A		Error	18.9 mA	15.2 mA
15 A		20.0 mA	16.0 mA	
16 A		Error	16.8 mA	
20 A		20.0 mA		

**Tab. 2:** Example of the output value of the analog output depending on the set factors and measures total current



## 7 Connection assignment



**Fig. 8:** Circuit diagram of the RCM 202-AB

Modbus (RS485 interface)		
Pin	Designation	Meaning
1	B+	D+/non-inverted signal
2	A-	D-/inverted signal
3		Reference potential (GND)
Analog and digital output connection		
1	AO1+	Analog output 1 (4 ... 20 mA sink +)
2	AO1-	Analog output 1 (4 ... 20 mA sink -)
3	AO2+	Analog output 2 (4 ... 20 mA sink +)
4	AO2-	Analog output 2 (4 ... 20 mA sink -)
5	-	-
6	1	Common connection for both digital outputs
7	2	Digital output 1
8	3	Digital output 2
Current measurement transformer connection		
1	I1 – K	Current measurement transformer 1, contact k (wire color <sup>1)</sup> : white)
2	I1 – L	Current measurement transformer 1, contact l (wire color <sup>1)</sup> : brown)
3	I2 – K	Current measurement transformer 2, contact k (wire color <sup>1)</sup> : white)
4	I2 – L	Current measurement transformer 2, contact l (wire color <sup>1)</sup> : brown)
Power supply connection		
1	N	Supply voltage AC 90 ... 230 V (N)
2	L	Supply voltage AC 90 ... 230 V (L)

**Tab. 3:** Connection assignment RCM 202-AB

Bus termination		
TERM switch	Switch position	Resistance
On ( <i>first and last bus participant</i> )	RH 	Resistance (120 Ω) switched on
Off	Left 	No resistance

**Tab. 4:** Bus termination via the TERM switch

<sup>1)</sup> for transformers with fixed connection cables with out contacts k and l

## 8 Application example

### 8.1 Application example RCM 202-AB in stand-alone mode

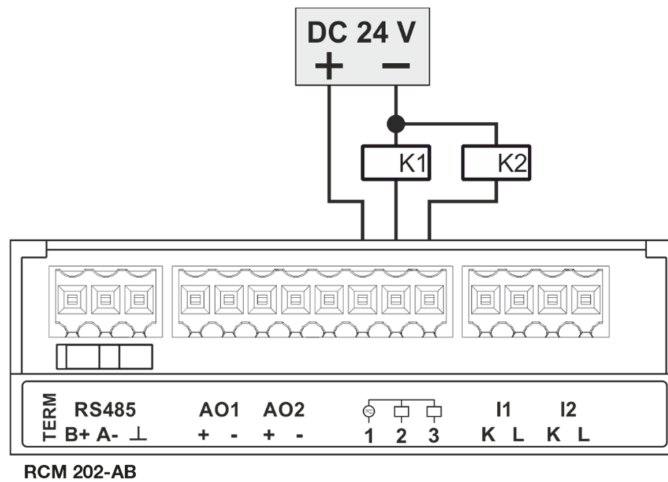


Fig. 9: Connection of two relays to the digital outputs

### 8.2 Application example analog outputs (interface 4 ... 20 mA)

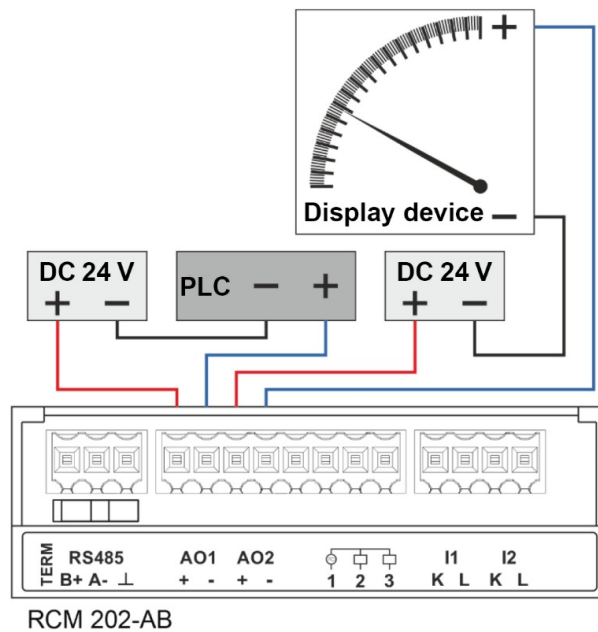
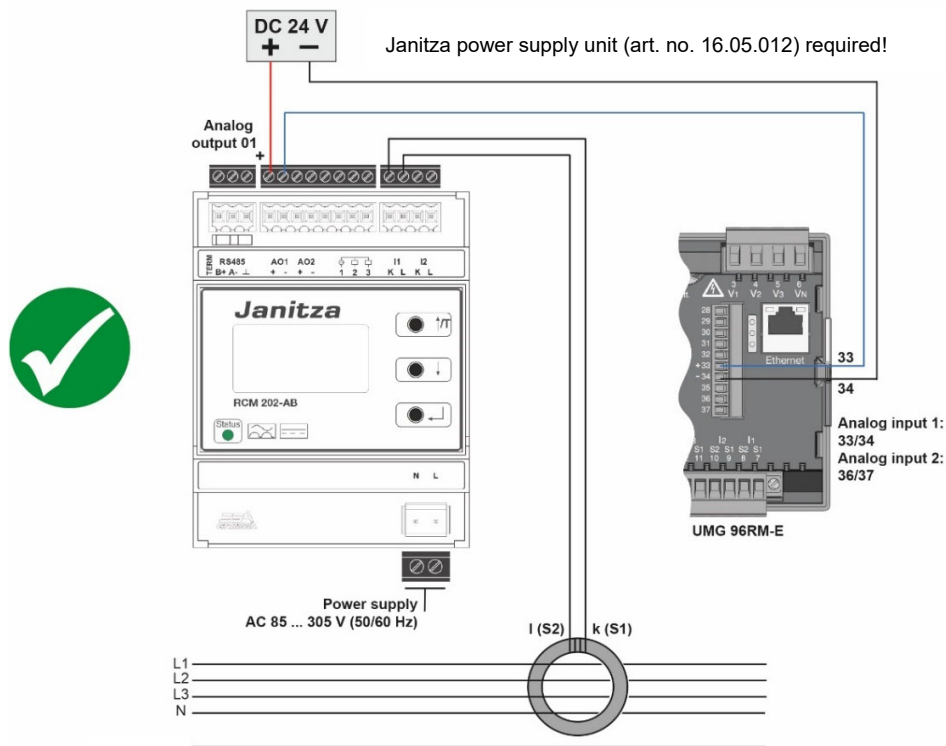


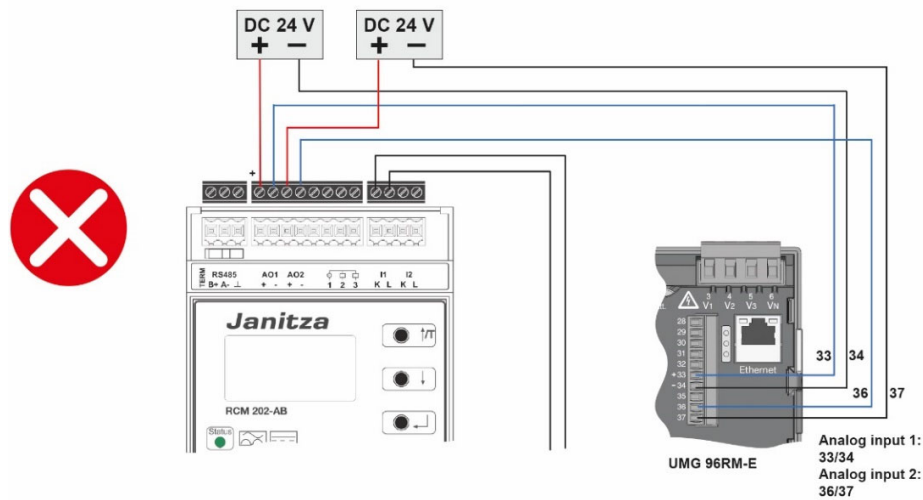
Fig. 10: Connection of a display device and a PLC to the analog outputs (Power supply: Janitza power supply unit, art. no. 16.05.012)

### 8.3 Application example analog outputs and UMG 96RM-E



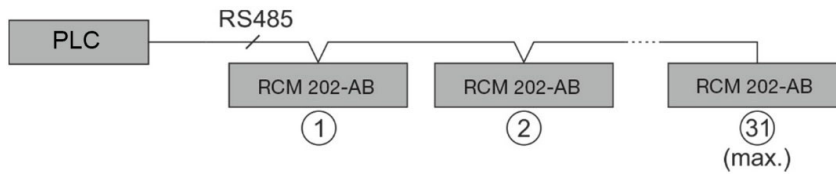
**Fig. 11b:** Connection to the analogue outputs of a UMG 96RM-E

The analogue outputs (AO1/AO2) may only be operated on galvanically isolated inputs/devices. Use a maximum of **ONE** analogue measurement circuit per measurement device (e.g. UMG 96RM-E) for the RCM 202-AB. Using **TWO** analogue channels between the RCM 202-AB and a device without galvanically isolated inputs leads to measurement errors (cf. Fig. 10c)!

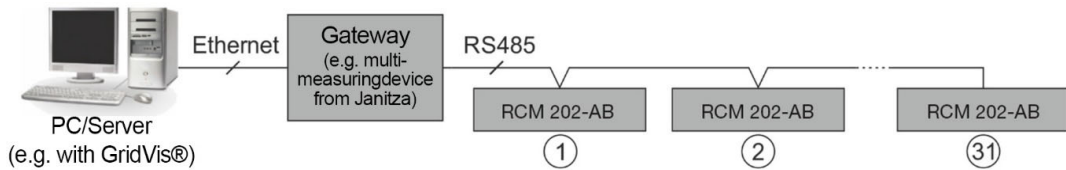


**Fig. 12c:** Invalid connection scheme

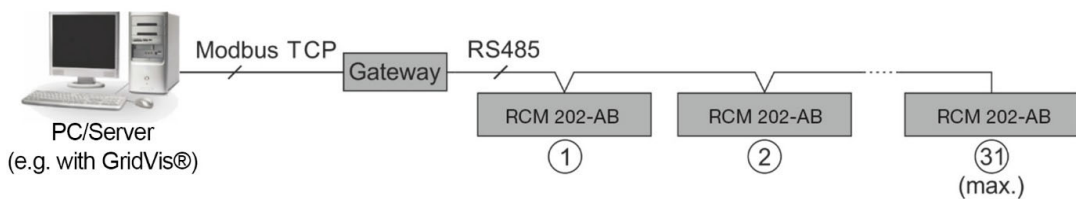
## 8.4 Application examples via Modbus (RS485 interface)



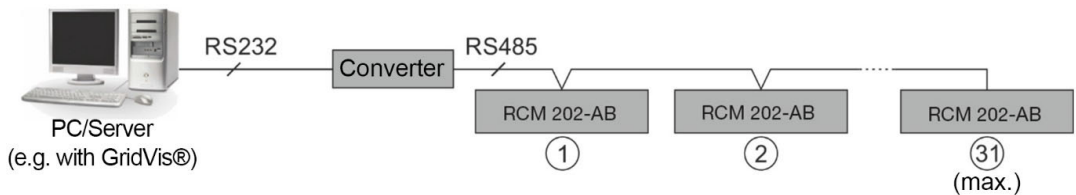
**Fig. 13:** Application example – PLC



**Fig. 14:** Application example – Measurement devices



**Fig. 15:** Application example – Modbus TCP



**Fig. 16:** Application example RS232/RS485



## 9 Assembly, commissioning and configuration



### ATTENTION

Assembly, connection and commissioning may only take place through qualified electrical personnel in compliance with the existing safety regulations and standards.

A line circuit breaker must be installed for the power supply of the RCM 202-AB. After commissioning, the connectors of the device must be protected against accidental contact by a cover if it is not ensured that only qualified personnel have access to the device.




### NOTE

Site information (e.g.: device designations), the installation in the Modbus segment, the serial number, the Modbus address (device address) as well as the designation of the current measurement transformer must be noted in the system documentation or taken from the supplied system documentation.

### 9.1 Assembly (initial installation)

The RCM 202-AB is installed in distribution boards and switchgears on a top hat rail (35 mm) according to DIN EN 60715.

Requirements: The current measurement transformers are already installed on the cables to be monitored.

1. Visually check the RCM 202-AB for damage.
2. Snap the RCM 202-AB onto the top hat rail.
3. Check the RCM 202-AB for tight fit.
4. Connect the plug of the RS485 interface to RCM 202-AB. Connect the ground connection of the RS485 interface  with the protective conductor PE.

**NOTE**

The device address 1 and the baud rate of 19200 baud are factory-set. If the RCM 202-AB is the first or last device in the Modbus line, the termination resistor must be set.

The ground terminals of all RS485 connections of multiple RCM 202-AB must be connected with the ground wire of the cable. The ground wire must be grounded in one point. The second wire pair of the bus cable is used as the ground wire. Both wires of the pair are parallel connected.

The shield may be applied only on one side!

5. Terminate the first and last bus participants within a bus segment by pushing the "Term" switch to the right.

**NOTE**

In the case of a RS485 connection from a control cabinet to a control cabinet, the Modbus connections B+ and A- must be electrically isolated.

6. Connect the current measurement transformer to the plug of the respective current measurement input (I1 and I2). When doing so, observe the connections K and L (see also Tab. 3 on page 21).
7. Connect the analog and digital outputs if necessary.
8. Make sure that the connected connectors are still firmly seated.
9. Retighten all screw connections.

## 9.2 Commissioning

**NOTE**

The housing of the RCM 202-AB warms up during operation.

1. Connect the plug for the power supply to the N/L connection. The status LED flashes green. RCM 202-AB initialization takes place. "I1 = ---" and "I2 = ---" appear on the display.
2. Wait until initialization is completed. Initialization can take up to 60 seconds. Initialization will take longer if the transformer measures residual currents already during initialization.

The status LED lights up green and the measured values for the activated measurement channels are shown on the display. The RCM 202-AB is ready for operation.

3. If necessary, configure the RCM 202-AB (see chapter 12) according to the system to be monitored and depending on the circuit of its connections.



### Observe the user manual!

The system documentation must be observed for the parameterization of the RCM 202-AB.

## 9.3 Configuration (parameterization)



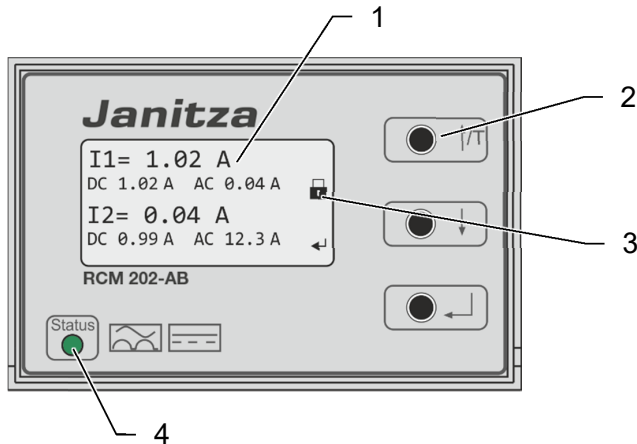
### NOTE

The set values must be documented and attached to the system documentation.

1. Check the set values and the control commands of the RCM 202-AB according to the system to be monitored and depending on the circuit of its connections. Change them if necessary.

## 10 Display and operating elements

### 10.1 Display and keys



**Fig. 17:** Front view of the RCM 202-AB during normal operation (no errors/faults)

- |   |  |   |              |
|---|--|---|--------------|
| 1 | Current measured values of the current measurement transformer or text message | 3 | Menu release |
| 2 | Keys   | 4 | Status LED   |

If the RCM 202-AB is in normal mode, e.g. without any errors or faults (see Fig. 17), the “main screen” is shown on the display:

1st row:	Current measured value of current measurement transformer 1
2nd row:	Direct current portion and alternating current portion of the measured residual current of current measurement transformer 1
3rd row:	Current measured value of current measurement transformer 2
4th row:	Direct current portion and alternating current portion of the measured residual current of current measurement transformer 2

The measured value that is displayed on the main screen is selected in the configuration menu (menu item “AC current value” in Menu “7.Service”). The following can be selected:

- Alternating current with frequencies up to 2 kHz
- Alternating current with frequencies up to 20 kHz
- Fundamental oscillation



#### NOTE

The backlight of the display shuts off automatically if no key is pressed for more than 10 minutes. If no key is pressed for more than 120 minutes, the display shuts off. The display or the backlight of the display are reactivated as soon as a key is pressed.

Response messages are displayed as text messages per channel:

2nd row:	Message regarding exceedance of the parameterized response threshold of current measurement transformer 1
4th row:	Message regarding exceedance of the parameterized response threshold of current measurement transformer 2

Row 1 and 3 remain unchanged. Only the message with the highest priority is displayed.

Error messages are displayed per channel as text messages:




1st row:	Error messages that concern current measurement transformer 1
2nd row:	empty
3rd row:	Error messages that concern current measurement transformer 2
4th row:	empty

In the case of multiple messages that occur at the same time, the message with the highest priority is displayed per channel. The messages do not require acknowledgment. The “main screen” appears again after correcting the error or eliminating the fault.



## 10.2 Meaning of the status LED

Condition of LED	Meaning
Off	No power supply
Green	RCM 202-AB ready for operation.
Flashing green	RCM 202-AB is started.
Yellow	Response values are exceeded, error detected
Red or flashing red	Error, RCM 202-AB faulty.

## 10.3 Key functions

Key	Image	Function
Up/test		Normal operation: Actuation $\geq 3$ s: Generation of an internal test signal; the monitoring function of RCM 202-AB is checked and messages are generated. Actuation $\geq 3$ s: no function
		Menu: Navigation in the submenus and between the menu items
		Parameterization mode: Setting the values
Down		Normal operation: No function
		Menu: Navigation in the submenus and between the menu items
		Parameterization mode: Setting the values
Enter		Normal operation: Calls up the menu
		Menu: Calls up the submenu and menu items
		Parameterization mode: Value transfer

## 10.4 Menu release






Symbol	Menus release status
	“Protected” The values in the menus “1.Service”, “4.Measured value memory”, “9.Information” and “10.Restart” can be viewed, changed and saved.
	“Released” The values in the configuration menu can be viewed, changed and saved.

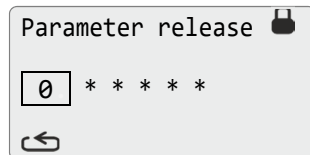
## 11 Operation

### 11.1 Release and block of parameterization mode

#### Release of parameterization mode

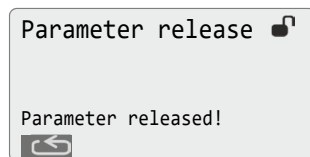
Initial situation: The RCM 202-AB is in normal mode, the “main screen” appears on the display.



1. Press . The main menu opens and menu item “1.Basic settings” is displayed with a dark background.
2. Press  again. The menu “1.Basic settings” is opened.
3. Use  or  to select the menu item “Parameter release”. The “Parameter release” menu item is displayed with a dark background.
4. Press . The “Parameter release” view appears.



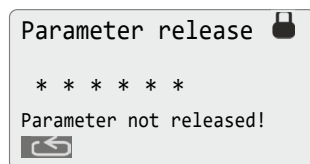
5. Set the number using  or  and confirm each number with . The password is a 6-digit number sequence. The factory setting is “000000”.

#### Input and confirmation of the correct number sequence




The symbol  on the display changes to . Parameterization mode is now active, which means that values can be changed and saved. The main screen appears again if no key is pressed for 60 seconds. Parameterization mode is blocked after an additional 60 seconds without pressing a key.

#### Input and confirmation of an incorrect number sequence



Parameterization mode is not released, which means that values cannot be changed or saved.

6. Press . Menu “1.Basic settings” is displayed again and menu item “LCD contrast” is displayed with a dark background.

## Blocking of parameterization mode



### NOTE

Parameterization mode is not blocked when “000000” is set as the password.

Initial situation: The RCM 202-AB is in normal mode.

1. Use or to select the menu item until the “main screen” appears on the display again.
2. Wait 60 seconds. The symbol on the display changes to . Parameterization mode is blocked.

## 11.2 Operating steps for displaying and changing values in the menu



### ATTENTION

Changes to the settings can be safety relevant!

Changes may only be made by an authorized electrician. In case of doubt, contact Janitza electronics GmbH.



### NOTE


To be able to view and change values in the menu, parameterization mode must be released. The values in the submenus “1.Service”, “4.Measured value memory”, “9.Information” and “10.Restart” can be viewed and changed also when the parameterization mode is blocked.

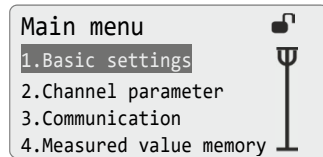
If no key is pressed in the menu for more than 60 seconds, the “main screen” appears again.



The operating steps apply analogously for all set values in the menu.

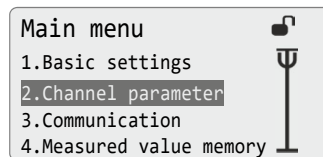
**Example:** Changing the response delay for measurement channel 1  
(menu item “response delay” in menu “2.Channel parameters”)

**Initial situation:** The main menu is shown on the RCM 202-AB display and parameterization mode is active.

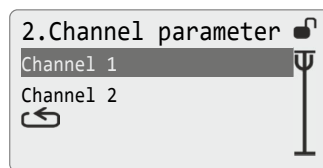
1. Press . The main menu is displayed.








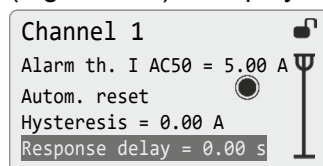
2. Use  or  to select the menu item “2. Channel parameter”. The “2. Channel parameter” menu item is displayed with a dark background.




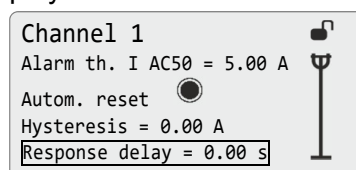
3. Press . The menu “2.Channel parameter” is opened.



4. Use  or  to select the menu item “Channel 1”. The “Channel 1” menu item is displayed with a dark background.
5. Press . The submenu “Channel 1” is opened.
6. Use  or  to select the menu item “Response delay”. The “Response delay” menu item is displayed with a dark background. The set value (e.g.: 0.00 s) is displayed.




7. Press  to change the set value. The menu item and set value are displayed bordered.

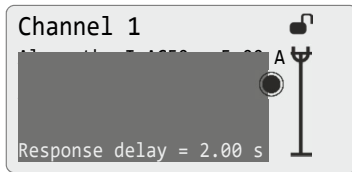






8. Use  or  to select the value item (e.g. 2.00 s).



**Saving the selected value:**

9. Press . The “Response delay” menu item is displayed with a dark background. The set value (e.g. 2.00 s) is displayed.



10. Use  or  to select the menu item . The menu item is displayed with a dark background.
11. Press . The superordinate menu (here: Main menu) is opened. The newly set value (2.00 s) is saved.


**Discarding the selected value:**

9. Do not press any key. The “main screen” appears again after 60 seconds.
10. Go again to the menu item “Response delay”
11. Check that the previously set value (0.00 s) is displayed.

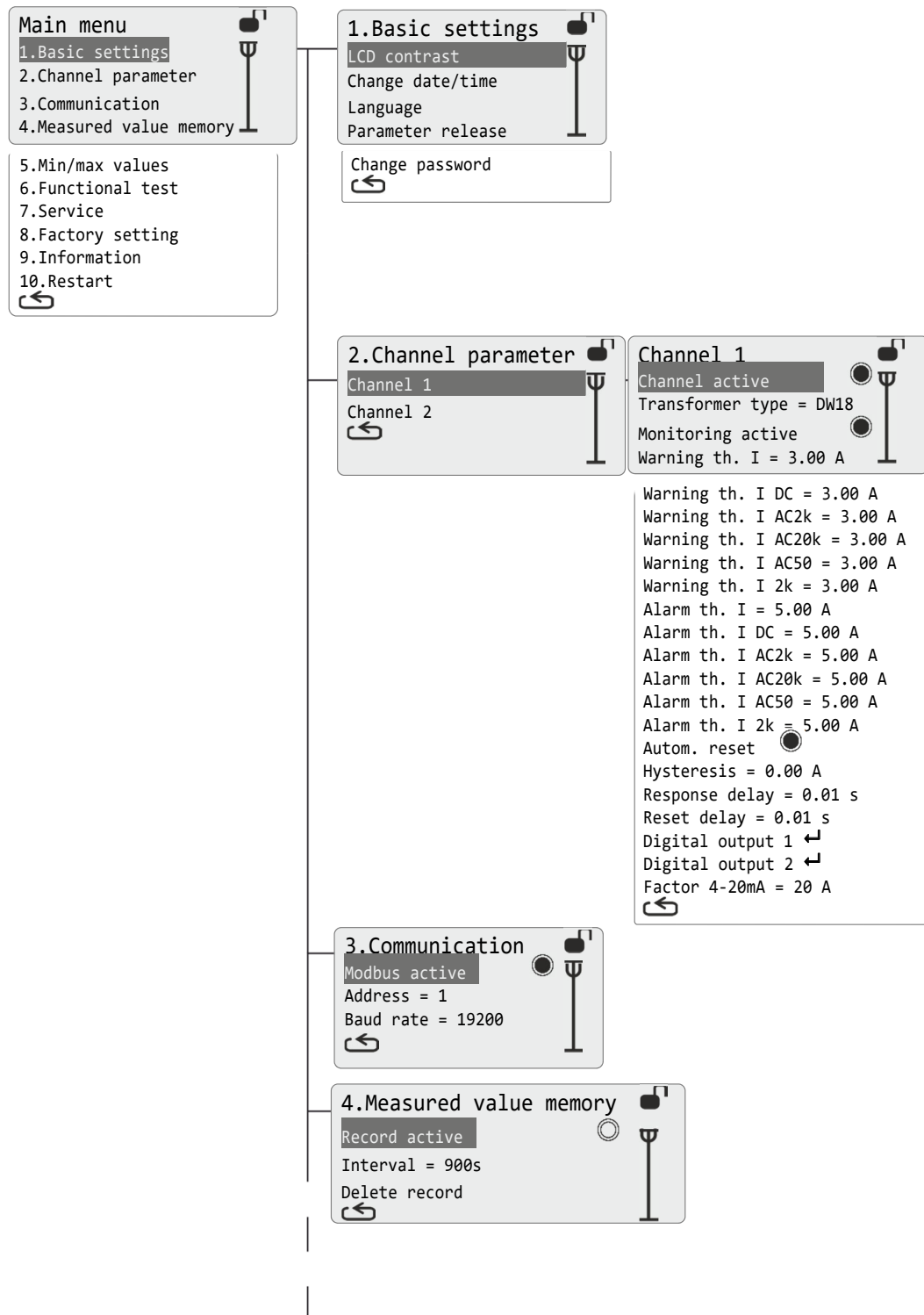
**11.3 Operating steps for checking the monitoring function****NOTE**

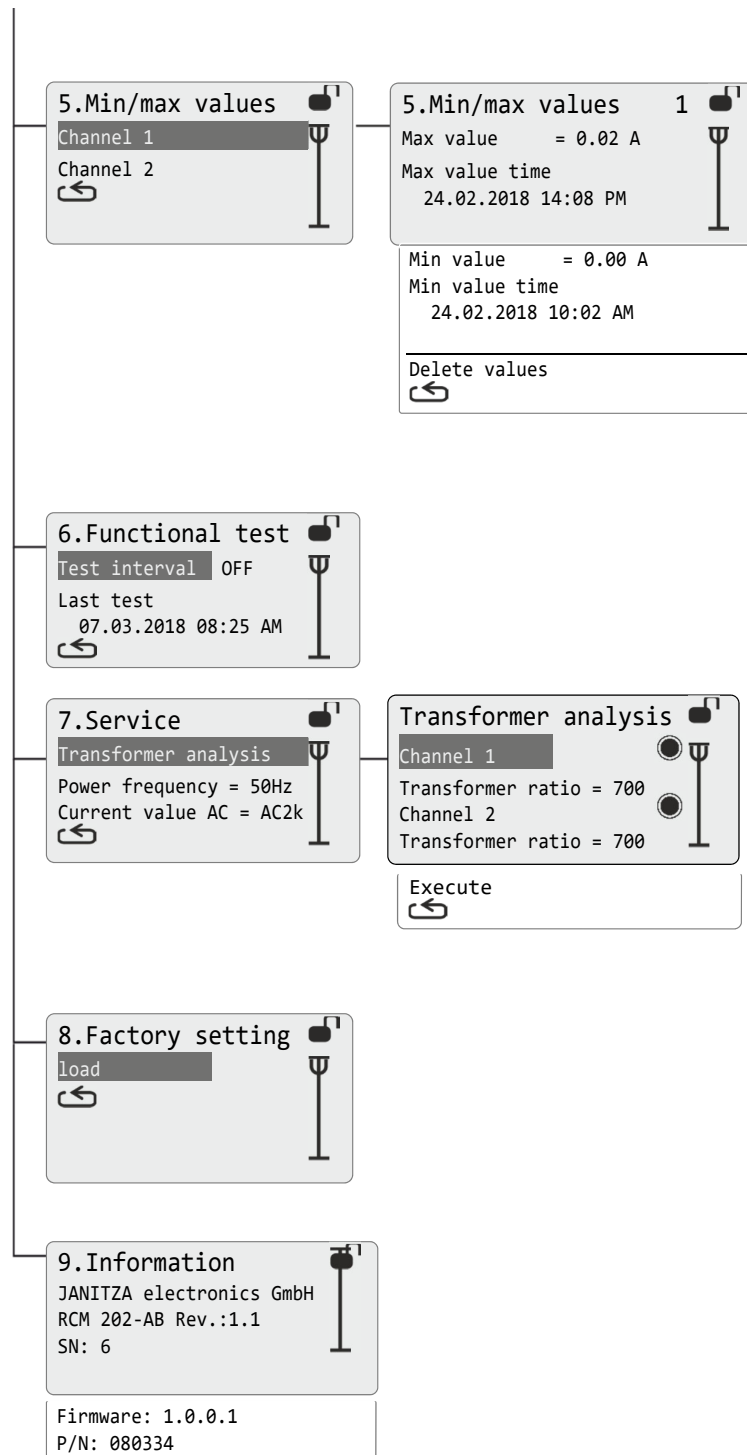
The performance of the test is saved with the time stamp and can be displayed in the menu “6.Functional test”.

Initial situation: The main screen is shown on the RCM 202-AB display.

1. Press  for at least 3 seconds. An internal test signal for testing the monitoring function is generated.
2. Make sure that the warning messages according to the set response values is shown on the display for both channels.
3. Make sure that the alarm messages according to the set response values is shown on the display for both channels.
4. Check that the exceedance of the warning and alarm thresholds is output on the utilized communication interfaces.

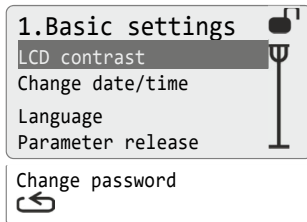
## 12 Configuration menu





**Fig. 18:** Menu structure (Menu "10.Restart" does not have submenus)

## 12.1 Menu: 1.Basic settings



**Fig. 19:** "1.Basic settings" menu

The menu items make it possible to set the following:

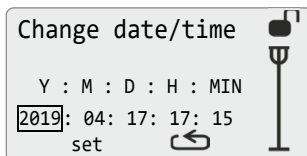
- Display contrast,
- Release of parameterization mode (password entry),
- Password change and
- Date and time.

### 12.1.1 Menu item: LCD contrast

Setting option: Display contrast (without password)



Shown on the display	Set values/control commands	Remark
LCD contrast 74 %	50 ... 85	In steps of 1

### 12.1.2 Menu item: Change date/time



**Fig. 20:** "Change date/time" submenu




Setting option: Change the date and time

Shown on the display	Set values/control commands	Remark
Y	2000 ... 2099	Year
M	01 ... 12	Month
D	01 ... 31	Day
H	00 ... 23	Hour
MIN	00 ... 59	Minute
set ↵	Selection with  / 	set: Accept the change ↵: Discard the change

### 12.1.3 Menu item: Language



#### ATTENTION

After selecting the required language with  or  and confirming with , the selected language is activated immediately!

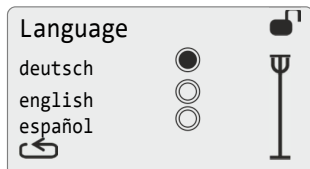


Fig. 21: “Language” submenu

Setting option: Selection of the language in which the menu items and text messages are shown on the display (without password)

Shown on the display	Set values/control commands	Remark
deutsch <input checked="" type="radio"/>	<input checked="" type="radio"/>	Language activated
english <input type="radio"/>	<input type="radio"/>	Language deactivated
español <input type="radio"/>	<input type="radio"/>	

### 12.1.4 Menu item: Parameter release



#### NOTE

It is only possible to view and change the set values and control commands in parameterization mode.



The values in the submenus “1.Service”, “4.Measured value memory”, “9.Information” and “10.Restart” can be viewed and changed also when the parameterization mode is blocked.


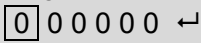




Observe the description of the release of the parameterization mode in chapter 11.1, on page 30.

Setting option: Activation of parameterization mode (password entry)

### 12.1.5 Menu item: Change password

Setting option: Changing the password

Shown on the display	Set values/control commands	Remark
Change password 0 0 0 0 0 ←	Selection of the position with  /  .	

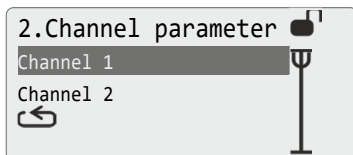
Shown on the display	Set values/control commands	Remark
Enter the new password	Activate editing the number with  .	
Change password  Enter the new password	6-digit number sequence	Confirm the set number with  .
Change password 1 2 3 4 5 6 		The new password is applied after confirming with  .
Change password 0 0 0 0 0 0  PW accepted!		

## 12.2 2.Channel parameter



### NOTE

Parameterization mode must be released in order to display the menu “2. Channel parameter”.



**Fig. 22:** “2.Channel parameter” menu

The menu items remain separated per channel make it possible to set the following:

- Channel activation,
- Transformer types,
- Transformer monitoring activation,
- Response values (warning and alarm) for the residual current in the monitored system,
- Hysteresis of the alarm thresholds,
- Response and delay times,
- Digital outputs and
- Interface (4 ... 20 mA).

## Menu items: Channel 1 and channel 2

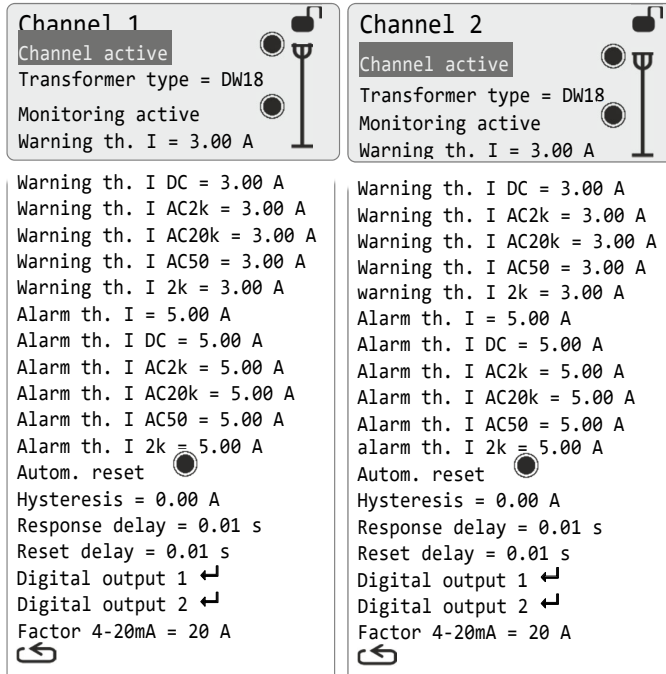


Fig. 23: “Channel 1” and “Channel 2” submenus

### 12.2.1 Menu item: Channel active

Setting option: Channel activation

Shown on the display	Set values/control commands	Remark
Channel active <input checked="" type="radio"/>	<input checked="" type="radio"/>	Channel activated
	<input type="radio"/>	Channel deactivated

### 12.2.2 Menu item: Transformer type

Setting option: Selection of the connected transformer type

Shown on the display	Set values/control commands	Remark
Transformer type= CT-AC 35N	Transformer types	See chapter 19.3, Tab. 5
	Transformer type determined by the transformer analysis	See chap. Fehler! Verweisquelle konnte nicht gefunden werden.

### 12.2.3 Menu item: Monitoring active

Setting option: Transformer monitoring activation

Shown on the display	Set values/control commands	Remark
Monitoring active <input checked="" type="radio"/>	<input checked="" type="radio"/>	Monitoring activated
	<input type="radio"/>	Monitoring deactivated

### 12.2.4 Menu items: Warning th. I to warning th. I AC50

Setting option: Threshold values for the triggering of warning messages

A message appears if the set value is exceeded (display, Modbus, if parameterized: digital output 1 and/or 2).

Shown on the display	Set values/control commands	Remark
Warning th. I = 3.00 A	0.03 ... 0.99 (steps of 0.01) 1.00 ... 4.90 (steps of 0.1) 5.00 ... 20.00 (steps of 1)	Total current with frequencies up to 20 kHz (residual current type B+)
Warning th. I DC = 3.00 A		Direct current
Warning th. I AC2k = 3.00 A		Alternating current with frequencies up to 2 kHz (residual current type A)
Warning th. I AC20k = 3.00 A		Alternating current with frequencies up to 20 kHz
Warning th. I AC50 = 3.00 A		Fundamental oscillation
Warning th. I 2k = 3.00 A		Total current with frequencies up to 2 kHz (residual current type B)



### 12.2.5 Menu items: Alarm th. I to alarm th. I AC50



#### NOTE

The response values for the alarm thresholds must be set higher than the response values for the warning thresholds.

Setting option: Threshold values for the triggering of alarm messages

A message appears if the set value is exceeded (display, Modbus, if parameterized: digital output 1 and/or 2).

Shown on the display	Set values/control commands	Remark
Alarm th. I = 5.00 A	0.03 ... 0.99 (steps of 0.01) 1.00 ... 4.90 (steps of 0.1) 5.00 ... 20.00 (steps of 1)	Total current with frequencies up to 20 kHz (residual current type B+)
Alarm th. I DC = 5.00 A		Direct current
Alarm th. I AC2k = 5.00 A		Alternating current with frequencies up to 2 kHz (residual current type A)
Alarm th. I AC20k = 5.00 A		Alternating current with frequencies up to 20 kHz
Alarm th. I AC50 = 5.00 A		Fundamental oscillation
Alarm th. I 2k = 5.00 A		Total current with frequencies up to 2 kHz (residual current type B)

### 12.2.6 Menu item: Autom. reset

Setting option: Activation of the automatic reset of warning and alarm messages after the end of the warning or alarm condition

Shown on the display	Set values/control commands	Remark
Autom. reset <input checked="" type="radio"/>	<input checked="" type="radio"/>	Automatic reset activated
	<input type="radio"/>	Automatic reset deactivated

### 12.2.7 Menu item: Hysteresis



#### ATTENTION

The hysteresis applies for all alarm thresholds of a channel and must always be less than the lowest alarm threshold!

Setting option: Threshold value for resetting the alarm messages

If the set value is fallen below, the message that the alarm threshold was exceeded ends (display, Modbus, if parameterized: digital output 1 and/or 2).

Shown on the display	Set values/control commands	Remark
Hysteresis = 0.00 A	0,00 ... 1.00 A	in steps of 0.01

### 12.2.8 Menu item: Response delay

Setting option: Time interval during which the exceedance of warning and alarm thresholds is not reported

Shown on the display	Set values/control commands	Remark
Response delay = 0.01 s	0.01 ... 10.00 s	in steps of 0.01

### 12.2.9 Menu item: Reset delay

Setting option: Time interval during which the warning and alarm messages remain active even though the warning thresholds or hysteresis were already fallen below

Shown on the display	Set values/control commands	Remark
Reset delay = 0.01 s	0.01 ... 10.00 s	in steps of 0.01

### 12.2.10 Menu items: Digital output 1 and digital output 2

Setting option: Message source for signaling via the digital output

Shown on the display	Set values/control commands	Remark
Warning threshold I 	<input checked="" type="radio"/>	Message source activated
... Overflow 	<input type="radio"/>	Message source deactivated

For the digital outputs, any number of message sources can be activated for both measurement channels.

Selection	Message for ...
Warning threshold I	Exceedance of the warning threshold for total current
Warning th. I DC	Exceedance of the warning threshold for direct current
Warning th. I AC2k	Exceedance of the warning threshold for alternating current with frequencies up to 2 kHz
Warning th. I AC20k	Exceedance of the warning threshold for alternating current with frequencies up to 20 kHz
Warning th. I AC50	Exceedance of the warning threshold for fundamental oscillation
Warning th. I 2k	Exceedance of the warning threshold for total current with frequencies up to 2 kHz
Alarm th. I	Exceedance of the alarm threshold for total current
Alarm th. I DC	Exceedance of the alarm threshold for direct current
Alarm th. I AC2k	Exceedance of the alarm threshold for alternating current with frequencies up to 2 kHz
Alarm th. I AC20k	Exceedance of the alarm threshold for alternating current with frequencies up to 20 kHz
Alarm th. I AC50	Exceedance of the alarm threshold for fundamental oscillation
Alarm th. I 2k	Exceedance of the alarm threshold for total current with frequencies up to 2 kHz
Transformer error	Transformer connection error
Offset error	Device error/measuring amplifier fault
Overflow	Exceedance of the measuring range

### 12.2.11 Menu item: Factor 4-20mA = 20 A

Setting option: Scaling of the measuring range to be evaluated

Shown on the display	Set values/control commands	Remark
Factor 4-20mA = 20 A	5 A, 10 A, 15 A, 20 A	4 mA = 0 A measured total current, 20 mA = max. 20 A measured total current (highest value = set value)

### 12.3 Menu: 3.Communication



#### NOTE

Parameterization mode must be released in order to display the menu "3.Communication".



#### Observe the user manual!

The annex to the user manual "Data and settings for the Modbus connection" must be strictly observed.

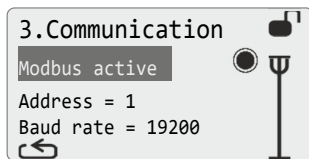


Fig. 24: "3.Communication" menu

The menu items make it possible to set the following:

- Communication interface RS485 (Modbus).

#### 12.3.1 Menu item: Modbus active



#### ATTENTION

The RCM 202-AB is a Modbus slave. The communication interface must be deactivated when the RCM 202-AB is not connected with a Modbus master.

Setting option:           Activation of the RS485 interface (Modbus)

Shown on the display	Set values/control commands	Remark
Modbus active <input checked="" type="checkbox"/>	<input checked="" type="radio"/>	Modbus activated
	<input type="radio"/>	Modbus deactivated

### 12.3.2 Menu item: Address



#### NOTE

Different addresses must be assigned to the RCM 202-ABs in the same bus segment.

Setting option: Modbus address of the RCM 202-AB

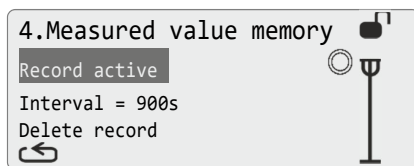
Shown on the display	Set values/control commands	Remark
Address = 1	1 ... 247	In steps of 1

### 12.3.3 Menu item: Baud rate

Setting option: Baud rate of the Modbus connection

Shown on the display	Set values/control commands	Remark
Baud rate = 19200	9600, 19200, 38400, 57600, 115200	

## 12.4 Menu: 4.Measured value memory



**Fig. 25:** “4.Measured value memory” menu

The menu items make it possible to set the following:

- Activation of measured value recording,
- Interval for averaging and
- Deleting the measured value memory.

#### 12.4.1 Menu item: Record active

Setting option: Activation of the measured value record (without password)

Shown on the display	Set values/control commands	Remark
Record active <input checked="" type="radio"/>	<input checked="" type="radio"/>	Record activated
	<input type="radio"/>	Record deactivated

### 12.4.2 Menu item: Interval

Setting option: Measurement interval for averaging (without password)

Shown on the display	Set values/control commands	Remark
Interval = 900 s	60 s, 300 s, 600 s, 900 s, 1800 s, 3600 s	


### 12.4.3 Menu item: Delete record



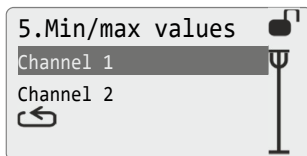
#### ATTENTION

There is no additional confirmation prompt!

Setting option: Deletion of the measured value memory (without password)

Shown on the display	Remark
Delete record	Press  to delete the stored measured values and extreme values.
Record deleted!	

### 12.5 Menu: 5.Min/max values

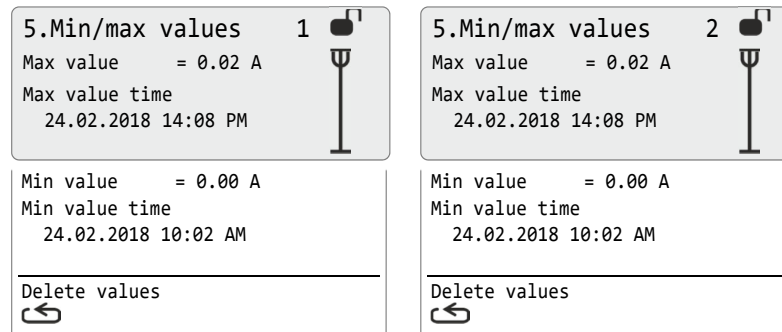


**Fig. 26:** 5."Min/max values" menu

The menu items offer the following options separated per channel:


- Display of the measured extreme values with time stamp and
- Deletion of the saved extreme values.

### 12.5.1 Menu items: Channel 1 and channel 2

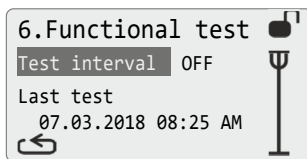


**Fig. 27:** Submenus "5.Min/max values 1" (menu item "Channel 1") and "5.Min/max values 2" (menu item "Channel 2")

Setting option: Display and deletion of the saved extreme values per channel

Shown on the display	Remark
5.Min/max values n	n = Number of the measurement channel whose extreme values are displayed.
Max value	Highest measured residual current (pulsating current) since the start of the record
Max value time	Time stamp of the maximum value
Min value	Lowest measured residual current (pulsating current) since the start of the record
Min value time	Time stamp of the minimum value
Delete values/ Values deleted ✓	Press  to delete the stored extreme values of the displayed measurement channel.

## 12.6 Menu: 6.Functional test



**Fig. 28:** "6.Functional test" menu

The menu items offer the following options:

- Setting the test intervals and
- Display of the last test.

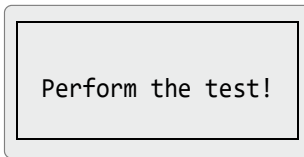
### 12.6.1 Menu item: Test interval

Setting option: Time interval until the next test to be performed, in months


Shown on the display	Set values/control commands	Remark
Test interval = <u>12 mon</u>	OFF	The reminder function is disabled.
	1 mon, 3 mon, 6 mon, 12 mon	The test date is calculated based on the set value and the last test.



After the test interval has elapsed, the message “Perform test” will be displayed instead of the main screen:




#### NOTE

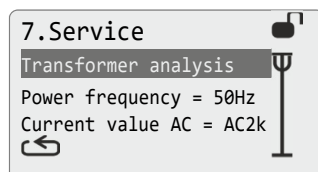
The test is started by pressing the key  for at least 3 s.

### 12.6.2 Menu item: last test

Setting option:            Display of the time stamp of the last test performed

Shown on the display	Remark
Last test dd.mm.yyyy HH:MM	The time stamp is set after the test for the monitoring function of RCM 202-AB is formed by pressing  . (dd = day, mm = month, yyyy = year, HH = hour, MM = minute)

### 12.7 Menu: 7.Service



**Fig. 29:** “7.Service” menu

The menu items make it possible to set the following:

- Analysis of the connected current measurement transformer
- Power frequency of the monitored system and
- Alternating current value displayed on the main screen.

### 12.7.1 Menu item: Transformer analysis

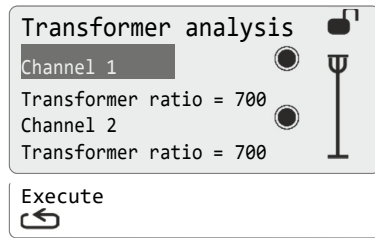


Fig. 30: "Transformer analysis" submenu

#### Menu items: Channel 1 and Channel 2

Setting option: Activation of the transformer analysis for the channel

Shown on the display	Set values/control commands	Remark
Channel 1 <input checked="" type="radio"/> Channel 2 <input checked="" type="radio"/>	<input checked="" type="radio"/>	Transformer analysis activated for the channel
	<input type="radio"/>	Transformer analysis deactivated for the channel

#### Menu items: Transformer ratio (per channel)

Setting option: Selection of the transformation ratio of the connected current measurement transformer

Shown on the display	Set values/control commands	Remark
Transformer ratio = 700	600 ... 1000	In steps of 10

#### Menu item: Execute



#### ATTENTION

Do not perform the transformer analysis if there is residual current!

Shown on the display	Remark
Execute	Confirm with . The RCM 202-AB determines the transformer characteristics required for the measurement method.
In progress	
Ended	The transformer analysis is complete. The RCM 202-AB does not provide feedback about the result of the analysis. If no error message is shown on the main screen, all characteristics can be determined.

### 12.7.2 Menu item: Power frequency

Setting option: Rated value of the power frequency in the monitored system

Shown on the display	Set values/control commands	Remark
Power frequency = 50 Hz	45 Hz to 60 Hz	In steps of 1

### 12.7.3 Menu item: Current value AC

Setting option: Selection of the alternating current that is displayed on the main screen

Shown on the display	Set values/control commands	Remark
Current value AC = AC50	AC2k	Alternating current with frequencies up to 2 kHz
	AC20k	Alternating current with frequencies up to 20 kHz
	AC50	Fundamental oscillation

## 12.8 Menu: 8.Factory setting

### Menu item: Load



#### ATTENTION

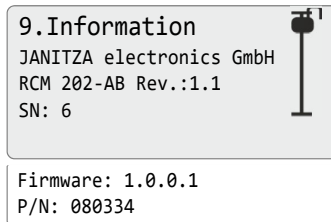
No additional confirmation prompts are displayed when parameterization mode is active. After the menu item is selected, the RCM 202-AB restarts.

Then check the set values and the control commands of the RCM 202-AB according to the system to be monitored and depending on the circuit of its connections. Change them if necessary.

Setting operation: Restore stored factory settings

Shown on the display	Remark
Load	Perform with
Load ✓	The RCM 202-AB restarts.

## 12.9 Menu: 9.Information



**Fig. 31:** "9.Information" menu

This menu contains the following information:

- Manufacturer,
- Device denomination and revision number,
- Serial number ("SN"),
- Firmware version,
- Item number ("P/N") of the RCM 202-AB.

## 12.10 Menu: 10.Restart

By selecting this menu with , the RCM 202-AB is restarted.

In this way, for example, it is possible to delete error messages on the display that were not reset after eliminating the fault or correcting the error. Information concerning which messages require this can be found in chapter 14.1.

## 13 Servicing

### 13.1 Periodic inspection



#### ATTENTION

The function of the system must be checked regularly and the test results must be documented.



#### NOTE

The functional test of the RCM 202-AB may only be carried out by authorized specialized personnel in coordination with the concerned area.

The applicable national and international standards which require regular inspections of electrical systems are to be observed.

Fault messages and erroneous functions are displayed by the LED and text messages of the RCM 202-AB. A visual inspection is to be performed in the course of the maintenance and inspection cycle for stationary electrical systems. This includes adherence to the installation conditions, tight fit of the plug connector and a check for visible damages.

### 13.2 Maintenance



#### NOTE

The RCM 202-AB is maintenance-free as an individual device.

However, it is recommended to perform maintenance on the system and the connection to the RCM 202-AB annually.

The RCM 202-AB independently monitors all internal functions and conditions of the connected current measurement transformer.

## 14 Troubleshooting



### ATTENTION

Faults that arise can be relevant to safety. They must be eliminated immediately by using approved spare parts or devices from the manufacturer/sales partner, if necessary.

Error messages and device errors are displayed by the LED and text messages and can be output via the digital outputs.

The measured values and current operating and error conditions can be transmitted via the RS485 interface (Modbus) to the display and evaluation devices as well as be connected to the building control system.

### 14.1 Errors and their remediation



### ATTENTION

If a fault cannot be eliminated, please contact the Service department.



### NOTE

If multiple possible causes are indicated for a text message, these can occur at the same time or individually.

**Error pattern:** The RCM 202-AB housing is warm



### NOTE

The RCM 202-AB housing warms up during operation up to 45 °C. Carry out the following troubleshooting only when the housing temperature is higher than 45 °C.

**Cause:** Device error

**Remediation:**

1. Disconnect the plug for the power supply from the N/L connection. The power supply for the RCM 202-AB is interrupted.
2. Contact the Janitza electronics GmbH Service department to replace the defective RCM 202-AB.

### 14.1.1 The status LED is off

**Text message:** None (display off, RCM 202-AB not ready for operation)

**Cause:** Power supply interrupted or device defective

**Remediation:**

1. Check the plug for the power supply on the bus connections on the RCM 202-AB for tight fit.
2. Check the power supply of the RCM 202-AB.
3. If necessary, replace the RCM 202-AB (see chapter 14.2 on page 58).

### 14.1.2 The status LED flashes green

**Text message:** I1 = --- and  
I2 = ---

**Cause:** Device initialization

**Remediation:**



**NOTE**

The initialization procedure can take multiple seconds.

1. Wait until the initialization procedure is completed.

### 14.1.3 The status LED lights up green

**Text message:** None (display off)

**Cause:** Device in sleep mode

**Remediation:**

1. Press any key.

**Text message:** I1 = --- or  
I2 = ---

**Cause:** Measurement channel deactivated

**Remediation:**

1. Check if the measurement channel is deactivated without a measured value (menu item "Channel active" in menu "2.Channel parameter").
2. Activate the channel if necessary.

#### 14.1.4 The status LED flashes yellow

**Text message:** Warning threshold [...] err.

**Cause:**

- Residual current in the monitored system
- Residual current > set warning threshold

**Remediation:**

1. Localize the defective consumer.
  - a) Switch off the outlets of the faulty system in succession until the message turns off.
  - b) Switch the defective circuit back on. The error message is displayed again.
  - c) Disconnect the individual devices connected to the defective circuit in succession from the supply voltage until the message disappears again.
2. Remove the defective device.

**Text message:** Alarm threshold [...] err.

**Cause:**

- Residual current in the monitored system
- Residual current > set alarm threshold

**Remediation:**

1. Localize the defective consumer.
  - a) Switch off the outlets of the faulty system in succession until the message turns off.
  - b) Switch the defective circuit back on. The error message is displayed again.
  - c) Disconnect the individual devices connected to the defective circuit in succession from the supply voltage until the message disappears again.
2. Remove the defective device.

#### 14.1.5 The status LED flashes red

**Text message:** Overflow

**Cause:** Measuring range exceeded

**Remediation:**

1. Check the currents to be measured with a multimeter.
2. If all currents are less than 20 A, the RCM 202-AB is defective and must be replaced.



**Text message:** Transformer error

**Cause:** Transformer connection error

**Remediation:**

1. Check if the channels are deactivated without a connected current measurement transformer.
2. Make sure that the current measurement transformer plug is firmly seated.
3. Make sure that the connections (lines) of the current measurement transformer, where the error occurred, are firmly seated.
4. Pull out the plug of the current measurement transformer.
5. Use a continuity tester to test lines k and l for the connected current measurement transformer, where the error occurred, for continuity.
6. If an electrically conductive connection does not exist, replace the current measurement transformer.
7. If there is an electrically conductive connection, replace the RCM 202-AB.
8. After completing the work, reconnect the plug of the current measurement transformer to the RCM 202-AB.
9. Make sure that the plug is firmly seated.

**Text message:** Offset error

**Cause:**

- Device error
- Fault of the measuring amplifier

**Remediation:**

1. Restart the RCM 202-AB by selecting menu item 10.
2. Disconnect the plug for the power supply from the N/L connection if necessary. The power supply for the RCM 202-AB is interrupted.
3. Wait 40 seconds and reconnect the plug for the power supply to the N/L connection. The power supply for the RCM 202-AB is restored.
4. Contact the Janitza electronics GmbH Service department if necessary to replace the defective RCM 202-AB.

#### 14.1.6 The status LED lights up red

**Text message:** none

**Cause:** Device defective

**Remediation:**

1. Contact the Janitza electronics GmbH Service department if necessary to replace the defective RCM 202-AB.

## 14.2 Replacement of a defective RCM 202-AB



### ATTENTION

Only trained specialized personnel may replace the RCM 202-AB. During replacement, monitoring functions are not operating! External peripheral devices also report errors/faults. When replacing the device during operation, the plugs must be disconnected and connected in the indicated sequence.



### NOTE


Update the serial number of the new device in the system documentation.

It is possible to change the device during operation without turning off the consumers. To prevent dangerous contact voltage on the terminals of the RCM 202-AB and to prevent the triggering of malfunctions, the sequence described below must be observed for the removal and reinstallation.

### 14.2.1 Removal of a defective RCM 202-AB

1. Disconnect the plug from the power supply (N/L). The power supply for the RCM 202-AB is interrupted.
2. Disconnect the connector for the analog and digital outputs.
3. Short-circuit the transformer disconnect terminal blocks.
4. Disconnect the plug of the current measurement transformer from the RCM 202-AB.
5. Disconnect the plug for the Modbus connection.
6. Unlock the RCM 202-AB and pull it off the top hat rail.
7. Deliver the defective RCM 202-AB to the service department or dispose of it properly.

### 14.2.2 Installation of a new RCM 202-AB

1. Visually check the new RCM 202-AB for damage.
2. Disconnect all plugs from the RCM 202-AB and store them in a safe place.
3. Snap the RCM 202-AB onto the top hat rail.
4. Check the device for tight fit.
5. Connect the plug of the RS485 interface to RCM 202-AB. Connect the ground connection of the RS485 interface  with the protective conductor PE.

**ATTENTION**

Set the “Term” switch according to the removed device.

6. If required, push the “Term” switch to the right.
7. Connect the current measurement transformer to the plug of the respective current measurement input (I1 and I2). Observe also the connections K and L.
8. Open the short-circuited transformer disconnect terminal blocks.
9. Connect the analog and digital outputs if necessary.
10. Make sure that the connected connectors are still firmly seated.
11. Connect the plug for the power supply to the N/L connection. The RCM 202-AB is ready for operation. The LED lights up green and the text messages display the current operating status of the monitored system.
12. If necessary, configure the RCM 202-AB according to the system to be monitored and depending on the circuit of its connections.

## 15 Warranty and liability

The general terms and conditions of Janitza electronics GmbH apply in the currently valid version.

## 16 Storage

Temporary storage of the device may only take place in enclosed spaces with observance of the storage temperature. Furthermore, the device is to be stored protected against direct effects of dust-, moisture and water.

## 17 Disposal



The device must be disposed of according to the applicable national and international regulations.

In Germany, the device is to be recycled as an electrical device. It may not be disposed with the household waste or as residual waste.

Used devices are taken back and disposed by Janitza electronics GmbH upon request.

## 18 Declaration of conformity

Product designation: Residual current monitoring device

Type: RCM 202-AB



The device has a CE mark. It fulfills the low voltage directive 2006/95/EC and the EMC Directive 2004/108/EC (for the considered standards, see chapter 19 on page 60).

The full text of the Declaration of Conformity can be requested from Janitza electronics GmbH.

## 19 Technical data

### 19.1 General technical data

Operating data	
Supply voltage $U_s$	AC 90 ... 230 V, 50/60 Hz
Required external back-up fuse for the power supply	Circuit breaker 1 pole, 3 A, AC 230 V
Operating mode	Continuous operation
Power consumption (internal consumption)	8 W
Isolation coordination according to IEC 60664-1	
Rated current $I_b$	4 kA
Rated surge voltage	4 kV
Pollution degree	2
Rated voltage	AC 250 V, 50 ... 60 Hz
Monitored system	
Measurement transformer types/transformation ratio:	
Residual current measuring transducer	See Tab. 5 on page 64
Current measurement transformer rated voltage	AC 20 ... 720 V
Current measurement transformer rated frequency	0 ... 20 kHz
Current measurement transformer rated current	(depending on the type)
Measurement channels	
Number of measuring channels	2 (connectable current measurement transformers)

Measured value recording	Parallel, effective value measurement (true RMS)
Evaluation	Residual currents Type A and B according to IEC 62020
Measurement response residual current $I_{GN}$	Parameterizable, 30 mA ... 20 A
Response delay time of the warning and alarm messages $t_v$	Parameterizable, 10 ms ... 10 s
Reset delay time $t_{vr}$	Parameterizable, 10 ms ... 10 s
<b>Transformer connections</b>	
Connection to the current measurement transformers	Line resistance max. 2 $\Omega$
Line/transformer	2-wire
<b>Line length:</b>	
Single wires (0.75 to 1.5 mm <sup>2</sup> )	max. 1 m
Twisted single wires (0.75 to 1.5 mm <sup>2</sup> )	max. 10 m
Shielded cable (0.75 to 1.5 mm <sup>2</sup> )	max. 10 m
<b>Displays, messages and memory</b>	
Full graphics display (LCD)	128 x 64 pixel with backlight
Status LED	3-color
Controls	3 keys
Menu languages	German, English, Spanish
Date and time	With RTC, stored in the non-volatile memory
Parameterization	On RCM 202-AB in the configuration menu
Messages	Display, LED, Modbus, digital outputs
Measured value memory	18,725 datasets (circular buffer) With date and time
<b>Examples:</b>	
Shielded cable 0.75 mm <sup>2</sup> (shield on I)	Max. length 20 m (21.87 yd)
Cable type J-Y(ST)Y $\varnothing$ 0.6 mm	Max. length 15 m (16.4 yd)
<b>Analog outputs</b>	
Interface	4 ... 20 mA
Quantity	2
Supply voltage of the analog outputs	DC 12 ... 24 V
<b>Digital outputs</b>	
Number of digital outputs	2
Switching voltage	max. DC 60 V, AC 30 V

Maximum current	350 mA
Start-up resistance	2 $\Omega$
Maximum cable length	up to 30 m (32.8 yd) unshielded, above 30 m (32.8 yd) shielded
<b>RS485 interface</b>	
Protocol	Modbus RTU (RCM 202-AB as the slave)
Interface	RS485
Baud rate	Parameterizable, 9.6 ... 115.2 kbaud
Address range	1 ... 247
max. cable length (38.4 kbaud)	1200 m (1212.3 yd)
Cable (shielded, shield one-sided on PE)	Unitronic Li2YCY(TP) 2x2x0.22 (Lapp cable)
Termination resistor	120 $\Omega$ (can be activated on the device)

<b>Device safety</b>	
Safety regulations for electrical measurement, control, regulation and laboratory devices	
Part 1: General requirements	IEC/EN 61010-1
Part 2-030: Particular requirements for equipment having testing or measuring circuits	IEC/EN 61010-2-030
<b>Electromagnetic compatibility (EMC)</b>	
<b>Immunity from interference</b>	
Class A: Industrial sector	IEC/EN 61326-1
Electrostatic discharges	IEC/EN 61000-4-2
Voltage dips	IEC/EN 61000-4-11
<b>Emissions</b>	
Class B: Residential sector	IEC/EN 61326-1
RFI field strength 30 ... 1000 MHz	IEC/CISPR11/EN 55011
Radiated interference voltage 0.15 ... 30 MHz	IEC/CISPR11/EN 55011
<b>Standards</b>	
The RCM 202-AB fulfills the requirements according to EN 62020:1998+A1:2005 (VDE 0663):2005	
<b>Ambient conditions</b>	
Ambient temperature during operation	-5 ... +55°C (23°F...131°F)
Ambient temperature during storage	-25 ... +70°C (-13°F...158°F)
Ambient temperature during transport	-25 ... +70°C (-13°F...158°F)

Altitude	0 ... 2000 m (0 ... 1.24 mi)
Climate category according to IEC 60721-3-3 (operation)	3K5
<b>Installation conditions</b>	
Installation position	Horizontal/vertical
Assembly	Top hat rail per DIN EN 60715
Device dimensions in mm (H x W x D)	71 x 90 x 73
Protection class according to EN 60529	IP 20
Protection class	II
Flammability rating	UL94V-0
Weight	Approx. 170 g (0.375 lb)
Connection type/cable	Series terminal/copper
Connection cross section single-wire/finely stranded	0.2 ... 4 mm <sup>2</sup> /0.2 ... 1.5 mm <sup>2</sup> (AWG 24-15)

## 19.2 RCM 202-AB plug

Designation	Connection	Quantity
Connector, Socket plug, 3-pin	RS485 (Modbus)	1
Connector, Socket plug, 8-pin	Analog and digital outputs	1
Connector, Socket plug, 4-pin	Transformer connection	1
Connector, Socket plug, 2-pin	Supply voltage	1

## 19.3 Current measurement transformer



### NOTE

There can be various labels on the transformer connections:

S1  $\triangleq$  k

S2  $\triangleq$  l



### NOTE

A cable length of 10 m between the transformer and the measurement device may not be exceeded. Observe the maximum cable resistance of 2 Ohm. Recommendations:

- Single wires (0.75 to 1.5 mm<sup>2</sup>): up to 1 m
- Twisted single wires (0.75 to 1.5 mm<sup>2</sup>) up to 10 m
- Shielded cable (0.75 to 1.5 mm<sup>2</sup>) up to 10 m



The following current measurement transformers can be connected to the RCM 202-AB:

Transformer type	Inner window mm	Separable	Transformation ratio	Max. primary current mA
DACT20	20	-	600:1	18000
CT-AC RCM 35N	35	-	700:1	20000
CT-AC RCM 80N	80	-	700:1	20000
CT-AC RCM 110N	110	-	700:1	20000
CT-AC RCM 140N	140	-	700:1	20000
CT-AC RCM 210N	210	-	700:1	20000
CT-AC RCM A110N	110	•	700:1	20000
CT-AC RCM A150N	150	•	700:1	20000
CT-AC RCM A310N	310	•	700:1	20000
KBU 23D	20 x 30	•	600:1	18000
KBU 58D	50 x 80	•	600:1	18000
KBU 812D	80 x 120	•	600:1	18000

**Tab. 5:** Current measurement transformer for RCM 202-AB





**Janitza electronics GmbH**

Vor dem Polstück 6  
**35633 Lahnau, Germany**

Support: +49 6441 9642-0  
E-mail: [info@janitza.de](mailto:info@janitza.de)  
[www.janitza.de](http://www.janitza.de)

**RCM 202-AB**

Residual current monitoring device

User manual

Issued by:

© Janitza electronics GmbH

Reprint only with approval of the publisher. All rights and changes reserved.